



Enjoy the freedom

**WARRANTY &
SERVICE HANDBOOK**

TOURERS

2006

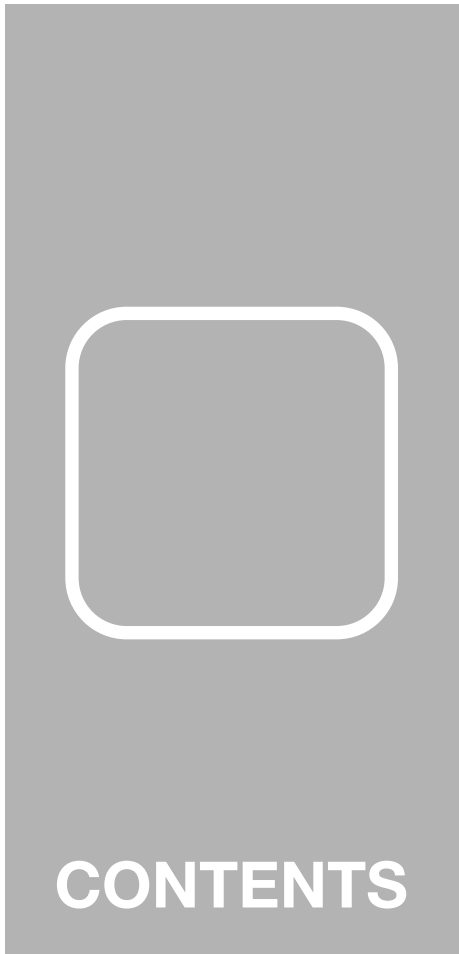
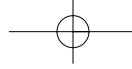

Warranty.....	2
What to do if you Require Assistance	4
Annual Service/Inspection Record	5
Specifications.....	8
Wiring Diagrams – Road Lights	12
Wiring Diagrams – Internal Wiring	15
Bulb Replacement	19
Change of Ownership	

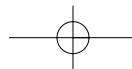
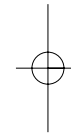
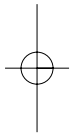

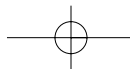

Warranty

All the illustrations and descriptive matter in this handbook are intended to give a general idea of the caravan. Changing market and supply situations and our policy of continuous product development may prevent us from maintaining the exact specifications detailed in this handbook. We therefore reserve the right to alter specifications as materials and conditions demand.

Dealers are not agents of Swift Group Limited, the manufacturer of Swift Group caravans and have absolutely no authority to bind the manufacturer by any express or implied undertaking or representation.

All caravans have a 3 year SuperSure manufacturer's warranty from the date of purchase (or hire purchase), which is subject to a chargeable annual service and inspection being carried out at an authorised Swift Group Service Centre.

During the warranty period, subject to the exclusions set out in this section of the handbook, the manufacturer, Swift Group Limited, will repair (or at its option, replace) all defective parts of the caravan.

The manufacturer will honour the warranty until 36 months from the date of sale, provided that the caravan has been serviced annually within 90 days before or 60 days after each anniversary of the

original date of sale. The third service must, however, be carried out before the expiry of the 36 month period from the original date of sale.

In the first 12 months the warranty will cover:

Faults arising from a manufacturing defect but not those which are a result of normal wear and tear or those which relate to replacement light bulbs.

Also not covered under the first year are faults resulting from accidental damage or damage caused by misuse of any component part of the caravan.

In the years two and three the warranty will cover:

1. All original components of the caravan including permanently fitted equipment forming part of the manufacturer's original specification.
2. Water ingress and body delamination.

Specific exclusions to SuperSure Warranty during years two and three

- Tyres including jockey wheel, glass including heat shields, sink lids, mirrors.
- Paintwork including all exterior paint, heat shields, heater cases and all other painted surfaces.

- Decals, mirror transfers, resin badges.
- GRP/ABS A frame covers, wheel spats and skirts.
- Cosmetic finishes to kitchen sinks, cooker tops, vanity units, shower trays.
- Soft furnishings including upholstery, curtains, pelmets.
- Carpets, lino and floor coverings including door mats, shower mats.
- Work surfaces, tables, and flaps.
- Wallboards, ceiling boards and all other interior décor finishes.
- Window catches, stays and associated fittings.
- Blinds and flyscreens including door, Heki and other rooflights.
- All hinges, catches, knobs, stays and handles (interior and exterior).
- Replacement of bulbs, fluorescent tubes, fuses and electrical connections including 12n and 12s plugs, high level brake lights and bulb contacts.
- Audio equipment including radios, speakers, aerials and associated parts.
- Bent jockey wheels, assemblies and corner steadies.

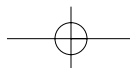

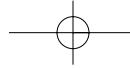

Warranty

- Fair wear and tear, accidental damage or any damage caused by the misuse of any component fitted by the manufacturer.
- Routine maintenance items which are part of the annual service including brake shoes, one shot nuts, lubricants, AKS pads, rubber gas hose, the cleaning of the heater and fridge flues, the replacement of gas jets, the resealing and/or replacement of shower room sealant, and the adjustment and lubrication of locks.

General terms applying to all three years of the warranty period

The caravan is not covered for:-

- The failure of a component for reasons of fair wear and tear.
- Damage resulting from accidents.
- Misuse of any component.
- Normal deterioration or negligence of any person other than the Swift Group Limited which causes stoppage of or impairment to the function of any component of the caravan.
- Replacement of parts which have reached the end of their effective working life because of age and/or usage.
- Cleaning or adjustment of any assemblies.

The warranty will be invalidated if the caravan has been neglected, misused or, modified or for hire or reward. The caravan will be deemed to have been neglected if it has not been serviced and maintained as stated in this handbook.

The warranty only applies to caravans purchased and used within the UK, and for continuous journeys abroad of no longer than 90 days per journey.

The cost of transporting, towing or moving the caravan by any means to or from the place of repair is the responsibility of the owner.

The benefit of this warranty may be transferred to a new owner if the caravan is sold, provided that the caravan has been serviced by an authorised Swift Group Service Centre in accordance with the requirements of this handbook, and details of the change of ownership have been supplied to Swift Group using the change of ownership form set out in this handbook. Failure to notify Swift Group of a change of ownership within 14 days of such a change will invalidate the warranty.

You have legal rights under UK law governing the sale of consumer goods. This warranty does not affect your legal rights.

The name and address of the warranty provider is:-

Swift Group Limited
Dunswell Road
Cottingham
East Yorkshire
HU16 4JX

To make a claim under this warranty, contact the Swift Group Service Centre which supplied your caravan. Alternatively, details of your nearest authorised Swift Group Service Centre can be obtained by contacting the Swift Group Customer Care Department on 01482 875740 or enquiring on our web site: www.swiftleisure.co.uk

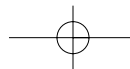

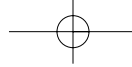

Assistance

WHAT TO DO IF YOU REQUIRE ASSISTANCE

Congratulations on purchasing an Ace product. We are confident that you will enjoy many happy holidays. However, should you have an enquiry or require assistance with a problem, we hope that this guide will be of assistance to you.

If you have a problem, or enquiry with regards to your new caravan, please follow these steps:

1. Check the Owners Handbook, paying particular attention to the fault finding advice at the back of the book.
2. Contact your supplying dealer for assistance.

If you need to contact the Swift Group, please be aware of the following:

1. When contacting Swift Supercare, please quote your name, postcode and serial number of your caravan, or build number of your motorhome.
2. In most instances, the Customer Care Team will involve your dealer in resolving the issue you are experiencing.
3. If you are contacting the company by email, letter or fax, the Customer Care Team will respond to you within five working days from the date of receiving the correspondence.
4. If you are calling the Customer Care Team, please avoid where possible, Mondays and lunch times.
5. Please be aware that the Swift Group cannot send parts direct from the factory. In all cases, without exception, your dealer must place the order for you.

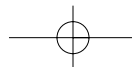
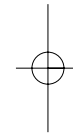
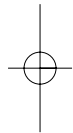

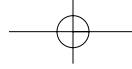

Service/Inspection

TOURING CARAVANS - ANNUAL SERVICE/INSPECTION RECORD

In order to comply with the warranty, you must have your caravan inspected and serviced by an authorised Swift Group Service Centre at least once per year.

It is important that the Owner's Handbook is stamped on the appropriate page by the authorised Swift Group Service Centre. Failure to do this will invalidate the warranty and the transfer of the warranty on the change of ownership.

The inspection should take approximately two to four hours and will cover the areas dealt with in the annual service check list. Any areas requiring service and/or maintenance will be highlighted by your dealer and we recommend that you authorise any necessary work to be carried out.

NB. It is essential, to validate the warranty, that an annual inspection be carried out by an authorised Swift Group Service Centre covering the items listed.

- | | |
|-------------------------------------------------|-------------------------------------------------|
| 1. Damp and lamination test. | 16. Water heater - gas and 230V AC (if fitted). |
| 2. Coupling head and breakaway cable. | 17. Hob, grill and oven (if fitted). |
| 3. Jockey wheel. | 18. Refrigerator 230V AC, 12V DC and gas. |
| 4. Chassis and chassis to body security. | 19. Gas system. |
| 5. Corner steadies. | 20. Water pump, taps and water system. |
| 6. Folding step (if fitted). | 21. Mains 230V AC system. |
| 7. Tyres and tyre pressures. | 22. Windows and fittings. |
| 8. Torque wheel nuts. | 23. Smoke alarm and battery. |
| 9. Brake rods and linkages. | 24. Roof lights. |
| 10. Hub bearings, brakes and brake shoes. | 25. Furniture hinges/stays etc. |
| 11. Handbrake operation and performance. | 26. Exterior locks and hinges. |
| 12. Suspension and shock absorbers (if fitted). | 27. Grab handle security. |
| 13. 12N and 12S 7-pin plugs and cables. | 28. All internal vents. |
| 14. Road lights, wiring and reflectors. | 29. Oil seals. |
| 15. Internal lights and 12V DC system. | 30. Blinds and fly screens (if fitted). |

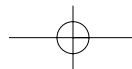
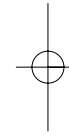
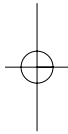

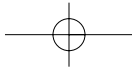

Service/Inspection

ANNUAL SERVICE/INSPECTION RECORD

CARAVAN MODEL _____ YEAR _____

CHASSIS NUMBER _____

<p>1st SERVICE</p> <p>DATE:</p> <p>DEALER'S STAMP</p> <p>We certify that an annual service has been carried out in accordance with the handbook.</p>	<p>2nd SERVICE</p> <p>DATE:</p> <p>DEALER'S STAMP</p> <p>We certify that an annual service has been carried out in accordance with the handbook.</p>
<p>3rd SERVICE</p> <p>DATE:</p> <p>DEALER'S STAMP</p> <p>We certify that an annual service has been carried out in accordance with the handbook.</p>	<p>4th SERVICE</p> <p>DATE:</p> <p>DEALER'S STAMP</p> <p>We certify that an annual service has been carried out in accordance with the handbook.</p>

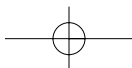
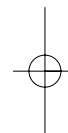
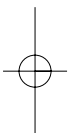

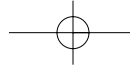

<p>5th SERVICE</p> <p>DATE:</p> <p>DEALER'S STAMP</p> <p>We certify that an annual service has been carried out in accordance with the handbook.</p>	<p>6th SERVICE</p> <p>DATE:</p> <p>DEALER'S STAMP</p> <p>We certify that an annual service has been carried out in accordance with the handbook.</p>
<p>7th SERVICE</p> <p>DATE:</p> <p>DEALER'S STAMP</p> <p>We certify that an annual service has been carried out in accordance with the handbook.</p>	<p>8th SERVICE</p> <p>DATE:</p> <p>DEALER'S STAMP</p> <p>We certify that an annual service has been carried out in accordance with the handbook.</p>
<p>9th SERVICE</p> <p>DATE:</p> <p>DEALER'S STAMP</p> <p>We certify that an annual service has been carried out in accordance with the handbook.</p>	<p>10th SERVICE</p> <p>DATE:</p> <p>DEALER'S STAMP</p> <p>We certify that an annual service has been carried out in accordance with the handbook.</p>

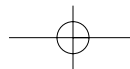
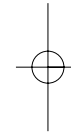
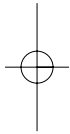

Specifications

JUBILEE	Diplomat	Ambassador	Envoy	Viceroy	Globetrotter
Berths	2	2	4	5	4
Axles	1	1	1	1	1
Internal Length (bed box height)	4.20m/13'9"	4.67m/15'4"	4.74m/15'7"	5.13m/16'10"	5.23m/17'2"
Overall Width	2.23m/7'4"	2.23m/7'4"	2.23m/7'4"	2.23m/7'4"	2.23m/7'4"
Overall Height (inc. TV Aerial)	2.70m/8'10"	2.70m/8'10"	2.70m/8'10"	2.70m/8'10"	2.70m/8'10"
Overall Length	5.88m/19'3"	6.35m/20'10"	6.42m/21'1"	6.81m/22'4"	6.91m/22'8"
Mass in Running Order (inc. tolerance)	998kg/19.6cwt	1057kg/20.8cwt	1063kg/20.9cwt	1161kg/22.9cwt	1167kg/23.0cwt
Essential Habitation Equipment Payload	68kg/1.3cwt	68kg/1.3cwt	68kg/1.3cwt	68kg/1.3cwt	68kg/1.3cwt
Personal Effects Payload	100kg/2.0cwt	105kg/2.1cwt	125kg/2.5cwt	139kg/2.7cwt	130kg/2.6cwt
Optional Equipment Payload	29kg/0.6cwt	29kg/0.6cwt	29kg/0.6cwt	29kg/0.6cwt	29kg/0.6cwt
Total user Payload	197kg/3.9cwt	202kg/4.0cwt	222kg/4.4cwt	236kg/4.6cwt	227kg/4.5cwt
Maximum Technical Permissible Laden Mass (DECLARED)	1195kg/23.5cwt	1259kg/24.8cwt	1285kg/25.3cwt	1397kg/27.5cwt	1394kg/27.5cwt
Maximum Technical Permissible Laden Mass (POSSIBLE)	1350kg/26.6cwt	1350kg/26.6cwt	1350kg/26.6cwt	1500kg/29.5cwt	1500kg/29.5cwt
Awning A/A dimension†	8.41m/27'7"	8.88m/29'2"	8.95m/29'4"	9.34m/30'8"	9.44m/31'0"
Tyre Size	195/70 r14**	195/70 r14**	195/70 r14**	175 r14 99	175 r14 99
Tyre pressure at DECLARED MTPLM	**	**	**	58 psi	58 psi
Tyre pressure at POSSIBLE MTPLM	**	**	**	65 psi	65psi
Static Load on Coupling Head	100kg	100kg	100kg	100kg	100kg
Thermal Insulation Grade	TWO	TWO	TWO	TWO	TWO
Bed Sizes					
Front Double	208cm x 180cm/6'10" x 5'11"	208cm x 180cm/6'10" x 5'11"	208cm x 134cm/6'10" x 4'5"	208cm x 180cm/6'10" x 5'11"	208cm x 180cm/6'10" x 5'11"
or One Single	190cm x 72cm/6'3" x 2'4"	180cm x 72cm/5'11" x 2'4"		190cm x 72cm/6'3" x 2'4"	190cm x 72cm/6'3" x 2'4"
and One Single	180cm x 72cm/5'11" x 2'4"	190cm x 72cm/6'3" x 2'4"		180cm x 72cm/5'11" x 2'4"	180cm x 72cm/5'11" x 2'4"
Rear Double			188cm x 138cm/6'2" x 4'6"	209cm x 133cm/6'10" x 4'4"	
Rear Bunk				194cm x 56cm/6'4" x 1'10"	
Side Single (offside)					180cm x 70cm/5'11" x 2'4"
Side Single (nearside)					
Side Bunk					178cm x 59cm/5'10" x 1'11"
Rear Lower Bunk					
Rear Upper Bunk					
Side Fixed Lower Bunk					
Side Fixed Upper Bunk					

****Alternative tyres:** Caravans fitted with **195/70 r14 95** have tyre pressure of **42psi**, caravans fitted with **195/70 r14 96** have a tyre pressure of **50psi**. Check the loading on the sidewall of the tyre before adjusting tyre pressure, replacing or purchasing a spare wheel and tyre. All tyres on the caravan must be of an identical size and load.

Bed sizes: Please note that double bed sizes are quoted with wrap round seating.

Specifications

JUBILEE	Herald	Statesman	Courier	Equerry
Berths	4	4	6	6
Axles	1	1	1	2
Internal Length (bed box height)	5.23m/17'2"	5.39m/17'8"	5.50m/18'1"	6.27m/20'7"
Overall Width	2.23m/7'4"	2.23m/7'4"	2.23m/7'4"	2.23m/7'4"
Overall Height (inc. TV Aerial)	2.70m/8'10"	2.70m/8'10"	2.70m/8'10"	2.70m/8'10"
Overall Length	6.91m/22'8"	7.07m/23'2"	7.18m/23'7"	7.94m/26'1"
Mass in Running Order (inc. tolerance)	1148kg/22.6cwt	1174kg/23.1cwt	1197cwt/23.6cwt	1344kg/26.5cwt
Essential Habitation Equipment Payload	68kg/1.3cwt	68kg/1.3cwt	68kg/1.3cwt	68kg/1.3cwt
Personal Effects Payload	130kg/2.6cwt	132kg/2.6cwt	153kg/3.0cwt	160kg/3.1cwt
Optional Equipment Payload	29kg/0.6cwt	29kg/0.6cwt	29kg/0.6cwt	29kg/0.6cwt
Total user Payload	227kg/4.5cwt	229kg/4.5cwt	250kg/4.9cwt	257kg/5.0cwt
Maximum Technical Permissible Laden Mass (DECLARED)	1375kg/27.1cwt	1403kg/27.6cwt	1447kg/28.5cwt	1601kg/31.5cwt
Maximum Technical Permissible Laden Mass (POSSIBLE)	1500kg/29.5cwt	1500kg/29.5cwt	1500kg/29.5cwt	1800kg/35.4cwt
Awning A/A dimension†	9.44m/31'0"	9.60m/31'6"	9.71m/31'10"	10.48m/34'5"
Tyre Size	175 r14 99	175 r14 99	175 r14 99	175/65 r14 82
Tyre pressure at DECLARED MTPLM	58 psi	62 psi	62 psi	44 psi
Tyre pressure at POSSIBLE MTPLM	65 psi	65 psi	65 psi	44 psi
Static Load on Coupling Head	100kg	100kg	100kg	100kg
Thermal Insulation Grade	TWO	TWO	TWO	TWO
Bed Sizes				
Front Double†	209cm x 139cm/6'10" x 4'7"	208cm x 167cm/6'10" x 5'6"	208cm x 180cm/6'10" x 5'11"	208cm x 180cm/6'10" x 5'11"
or One Single	190cm x 72cm/6'3" x 2'4"	190cm x 72cm/6'3" x 2'4"	180cm x 72cm/5'11" x 2'4"	180cm x 72cm/5'11" x 2'4"
and One Single	190cm x 72cm/6'3" x 2'4"	167cm x 72cm/5'6" x 2'4"	180cm x 72cm/5'11" x 2'4"	190cm x 72cm/6'3" x 2'4"
Rear Double		198cm x 138cm/6'6" x 4'6"		
Rear Bunk				
Side Single (offside)	180cm x 70cm/5'11" x 2'4"			
Side Single (nearside)			180cm x 70cm/5'11" x 2'4"	180cm x 70cm/5'11" x 2'4"
Side Bunk	178cm x 59cm/5'10" x 1'11"		178cm x 59cm/5'10" x 1'11"	178cm x 59cm/5'10" x 1'11"
Rear Lower Bunk			180cm x 62cm/5'11" x 2'1"	
Rear Upper Bunk			184cm x 60cm/6'0" x 2'0"	
Side Fixed Lower Bunk				180cm x 56cm/5'11" x 1'10"
Side Fixed Upper Bunk				180cm x 58cm/5'11" x 1'11"

Bed sizes: Please note that double bed sizes are quoted with wrap round seating.

†Note on awning sizes: Due to the varying awning designs and sizes the awning sizes given are approximate only. Specific awning sizes must be confirmed by your dealer or the awning manufacturer prior to purchase.

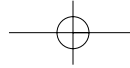

Specifications

AWARD	Brightstar	Dawnstar	Morningstar	Transtar	Northstar	Tristar	Nightstar
Berths	2	2	4	4	4	4	5
Axles	1	1	1	1	1	1	1
Internal Length (bed box height)	4.61m/15'2"	4.61m/15'2"	5.23m/17'2"	5.23m/17'2"	5.39m/17'8"	5.39m/17'8"	5.39m/17'8"
Overall Width	2.23m/7'4"	2.23m/7'4"	2.23m/7'4"	2.23m/7'4"	2.23m/7'4"	2.23m/7'4"	2.23m/7'4"
Overall Height (inc. TV Aerial)	2.76m/9'1"	2.76m/9'1"	2.76m/9'1"	2.76m/9'1"	2.76m/9'1"	2.76m/9'1"	2.76m/9'1"
Overall Length	6.26m/20'6"	6.26m/20'6"	6.88m/22'7"	6.88m/22'7"	7.04m/23'1"	7.04m/23'1"	7.04m/23'1"
Mass in Running Order (inc. tolerance)	1112kg/21.9cwt	1102kg/21.7cwt	1207kg/23.8cwt	1189kg/23.4cwt	1216kg/23.9cwt	1218kg/24.0cwt	1241kg/24.4cwt
Essential Habitation Equipment Payload	68kg/1.3cwt	68kg/1.3cwt	68kg/1.3cwt	68kg/1.3cwt	68kg/1.3cwt	68kg/1.3cwt	68kg/1.3cwt
Personal Effects Payload	104kg/2.0cwt	104kg/2.0cwt	130kg/2.6cwt	130kg/2.6cwt	132kg/2.6cwt	132kg/2.6cwt	142kg/2.8cwt
Optional Equipment Payload	17kg/0.3cwt	30kg/0.6cwt	17kg/0.3cwt	17kg/0.3cwt	17kg/0.3cwt	17kg/0.3cwt	17kg/0.3cwt
Total user Payload	189kg/3.6cwt	202kg/3.9cwt	215kg/4.2cwt	215kg/4.2cwt	217kg/4.2cwt	217kg/4.2cwt	227kg/4.4cwt
Maximum Technical Permissible Laden Mass (DECLARED)	1301kg/25.5cwt	1304kg/25.6cwt	1422kg/28.0cwt	1404kg/27.6cwt	1433kg/28.1cwt	1435kg/28.2cwt	1468kg/28.8cwt
Maximum Technical Permissible Laden Mass (POSSIBLE)	1350kg/26.6cwt	1350kg/26.6cwt	1500kg/29.5cwt	1500kg/29.5cwt	1500kg/29.5cwt	1500kg/29.5cwt	1500kg/29.5cwt
Awning A/A dimension†	8.90m/29'2"	8.90m/29'2"	9.52m/31'3"	9.52m/31'3"	9.68m/31'9"	9.68m/31'9"	9.68m/31'9"
Tyre Size	195/70 r14**	195/70 r14**	175 r14 99	175 r14 99	175 r14 99	175 r14 99	175 r14 99
Tyre pressure at DECLARED MTPLM	**	**	62 psi	62 psi	62 psi	62 psi	62 psi
Tyre pressure at POSSIBLE MTPLM	**	**	65 psi	65 psi	65 psi	65 psi	65 psi
Static Load on Coupling Head	100kg	100kg	100kg	100kg	100kg	100kg	100kg
Thermal Insulation Grade	TWO	TWO	TWO	TWO	TWO	TWO	TWO
Bed Sizes							
Front Double†	208cm x 190cm 6'10" x 6'3"	208cm x 190cm 6'10" x 6'3"	208cm x 180cm 6'10" x 5'11"	208cm x 139cm 6'10" x 4'7"	208cm x 166cm 6'10" x 5'5"	208cm x 139cm 6'10" x 4'7"	208cm x 180cm 6'10" x 5'11"
or One Single	190cm x 71cm 6'3" x 2'4"	190cm x 71cm 6'3" x 2'4"	190cm x 71cm 6'3" x 2'4"	190cm x 71cm 6'3" x 2'4"	190cm x 71cm 6'3" x 2'4"		190cm x 71cm 6'3" x 2'4"
and One Single	190cm x 71cm 6'3" x 2'4"	190cm x 71cm 6'3" x 2'4"	180cm x 71cm 5'11" x 2'4"	190cm x 71cm 6'3" x 2'4"	166cm x 71cm 5'5" x 2'4"		180cm x 71cm 5'11" x 2'4"
Rear Double					196cm x 138cm 6'5" x 4'6"	190cm x 138cm 6'3" x 4'6"	192cm x 138cm 6'4" x 4'6"
Rear Bunk							192cm x 58cm 6'4" x 1'11"
Side Single (offside)			180cm x 66cm 5'11" x 2'2"	180cm x 66cm 5'11" x 2'2"			
Side Bunk			178cm x 56cm 5'10" x 1'10"	178cm x 56cm 5'10" x 1'10"			

****Alternative tyres:** Caravans fitted with 195/70 r14 95 have tyre pressure of 42psi, caravans fitted with 195/70 r14 96 have a tyre pressure of 50psi. Check the loading on the sidewall of the tyre before adjusting tyre pressure, replacing or purchasing a spare wheel and tyre. All tyres on the caravan must be of an identical size and load.

Bed sizes: Please note that double bed sizes are quoted with wrap round seating.

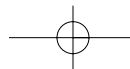

Specifications

SUPREME	Superstar	Globestar	Twinstar	Sunstar
Berths	5	4	4	5 opt 6
Axles	2	2	2	2
Internal Length (bed box height)	6.27m/20'7"	6.27m/20'7"	6.27m/20'7"	6.27m/20'7"
Overall Width	2.23m/7'4"	2.23m/7'4"	2.23m/7'4"	2.23m/7'4"
Overall Height (inc. TV Aerial)	2.76m/9'1"	2.76m/9'1"	2.76m/9'1"	2.76m/9'1"
Overall Length	7.92m/26'0"	7.92m/26'0"	7.92m/26'0"	7.92m/26'0"
Mass in Running Order (inc. tolerance)	1429kg/28.1cwt	1408kg/27.7cwt	1467kg/28.9cwt	1456kg/28.7cwt
Essential Habitation Equipment Payload	105kg/2.1cwt	105kg/2.1cwt	105kg/2.1cwt	105kg/2.1cwt
Personal Effects Payload	150kg/3.0cwt	140kg/2.8cwt	140kg/2.8cwt	160kg/3.1cwt
Optional Equipment Payload	53kg/1.0cwt	53kg/1.0cwt	53kg/1.0cwt	73kg/1.4cwt
Total user Payload	308kg/6.1cwt	298kg/5.9cwt	298kg/5.9cwt	338kg/6.6cwt
Maximum Technical Permissible Laden Mass (DECLARED)	1737kg/34.2cwt	1706kg/33.6cwt	1765kg/34.8cwt	1794kg/35.3cwt
Maximum Technical Permissible Laden Mass (POSSIBLE)	1800kg/35.4cwt	1800kg/35.4cwt	1800kg/35.4cwt	1800kg/35.4cwt
Awning A/A dimension†	10.50m/34'5"	10.50m/34'5"	10.50m/34'5"	10.50m/34'5"
Tyre Size	175/65 r14 82	175/65 r14 82	175/65 r14 82	175/65 r14 82
Tyre pressure at DECLARED MTPLM	44 psi	44 psi	44 psi	44 psi
Tyre pressure at POSSIBLE MTPLM	44 psi	44 psi	44 psi	44 psi
Static Load on Coupling Head	100kg	100kg	100kg	100kg
Thermal Insulation Grade	TWO	TWO	TWO	TWO
Bed Sizes				
Front Double†	208cm x 180cm/6'10" x 5'11"	208cm x 180cm/6'10" x 5'11"	208cm x 139cm/6'10" x 4'7"	208cm x 180cm/6'10" x 5'11"
or One Single	180cm x 71cm/5'11" x 2'4"	182cm x 71cm/6'0" x 2'4"		190cm x 71cm/6'3" x 2'4"
and One Single	190cm x 71cm/6'3" x 2'4"	180cm x 71cm/5'11" x 2'4"		180cm x 71cm/5'11" x 2'4"
Rear Double	208cm x 138cm/6'10" x 4'6"	186cm x 134cm/6'1" x 4'5"	192cm x 138cm/6'4" x 4'6"	
Rear Bunk	192cm x 58cm/6'4" x 1'11"			
Side Single (nearside)				180cm x 66cm/5'11" x 2'2"
Side Fixed Lower Bunk				182cm x 66cm/6'0" x 2'2"
Side Fixed Upper Bunk				184cm x 68cm/6'0" x 2'2"
Optional Bunk				172cm x 56cm/5'8" x 1'10"

Bed sizes: Please note that double bed sizes are quoted with wrap round seating.

†Note on awning sizes: Due to the varying awning designs and sizes the awning sizes given are approximate only. Specific awning sizes must be confirmed by your dealer or the awning manufacturer prior to purchase.

Wiring Diagrams

JUBILEE 2006 - ROAD LIGHTS

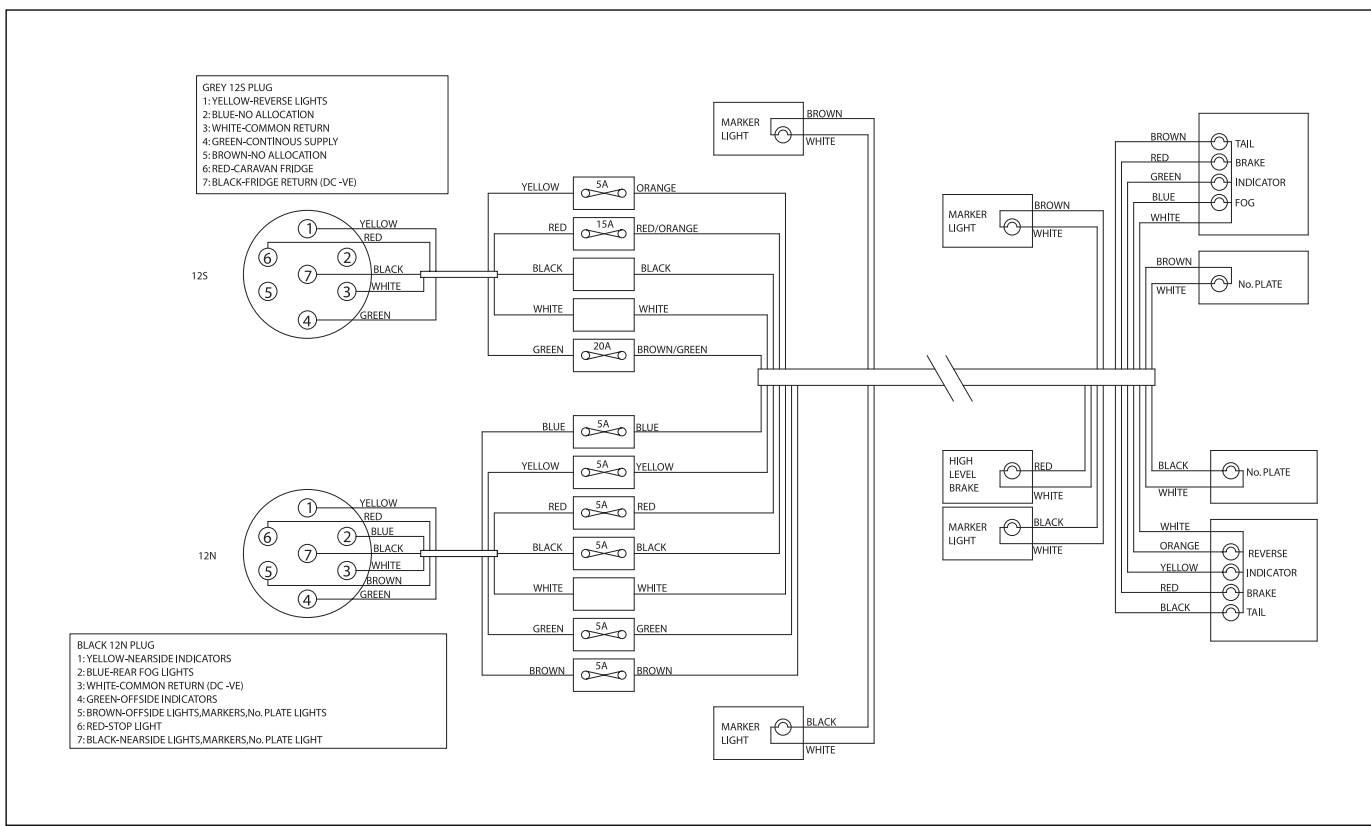

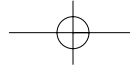

Wiring Diagrams

AWARD RANGE 2006 - ROAD LIGHTS

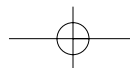
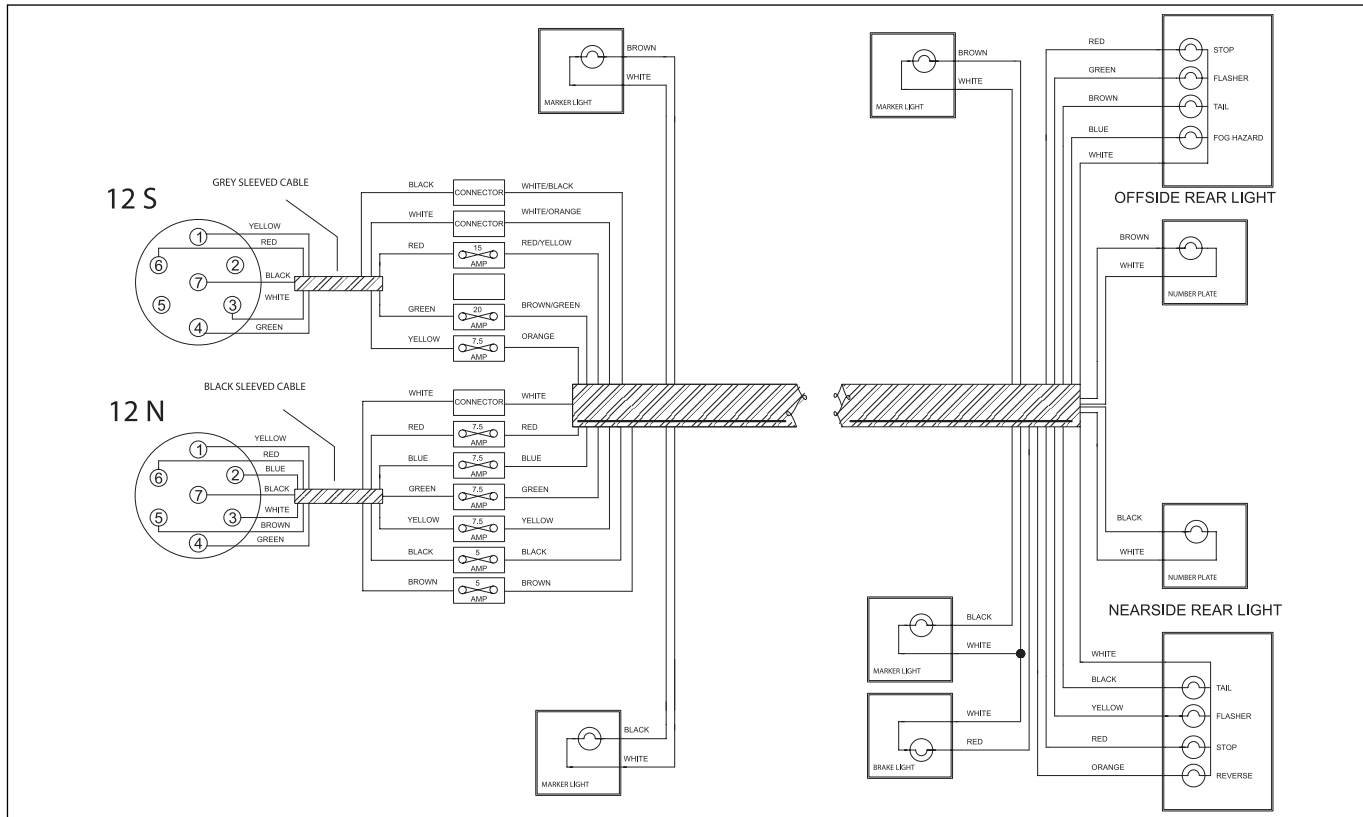

Wiring Diagrams

SUPREME RANGE 2006 - ROAD LIGHTS

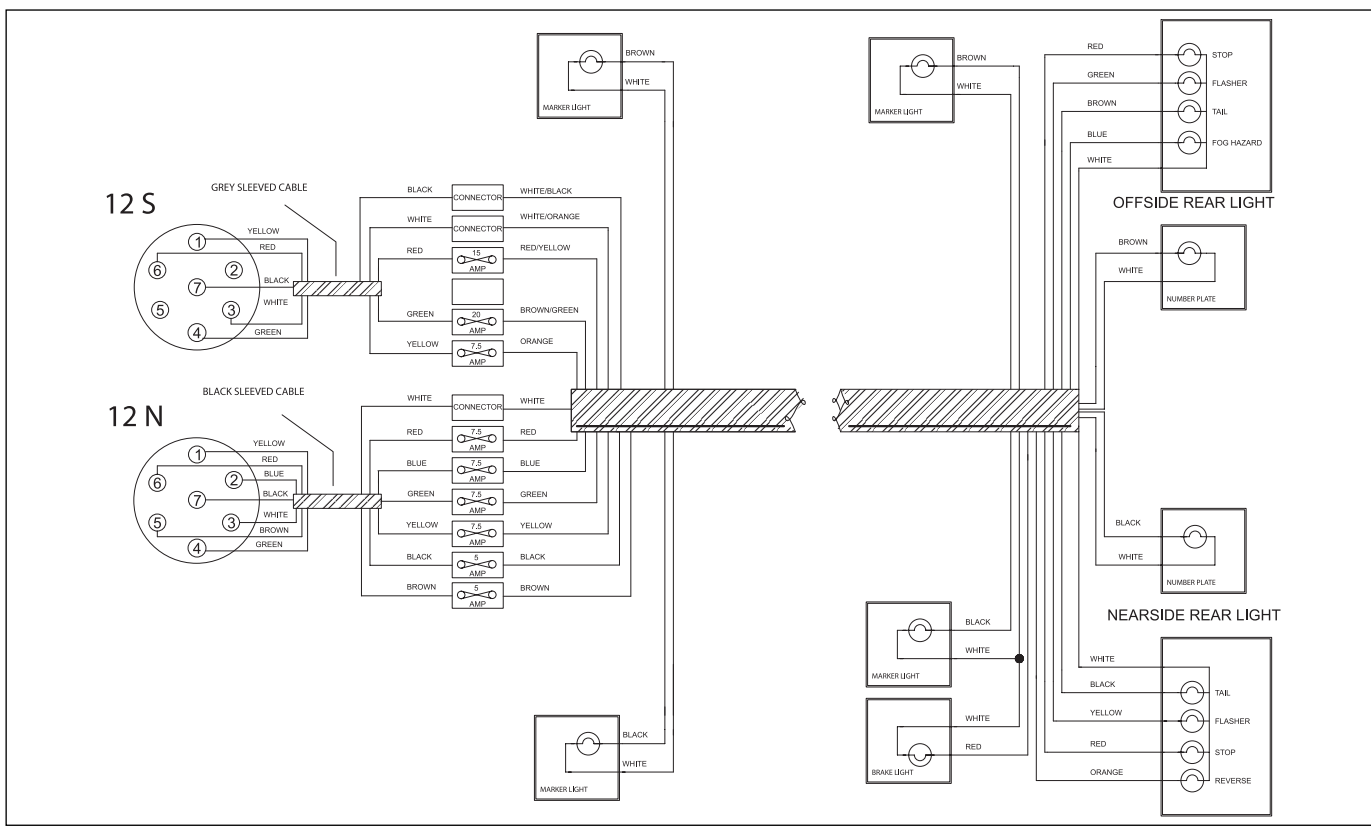

Wiring Diagrams

JUBILEE RANGE 2006 - 12V AND 230V

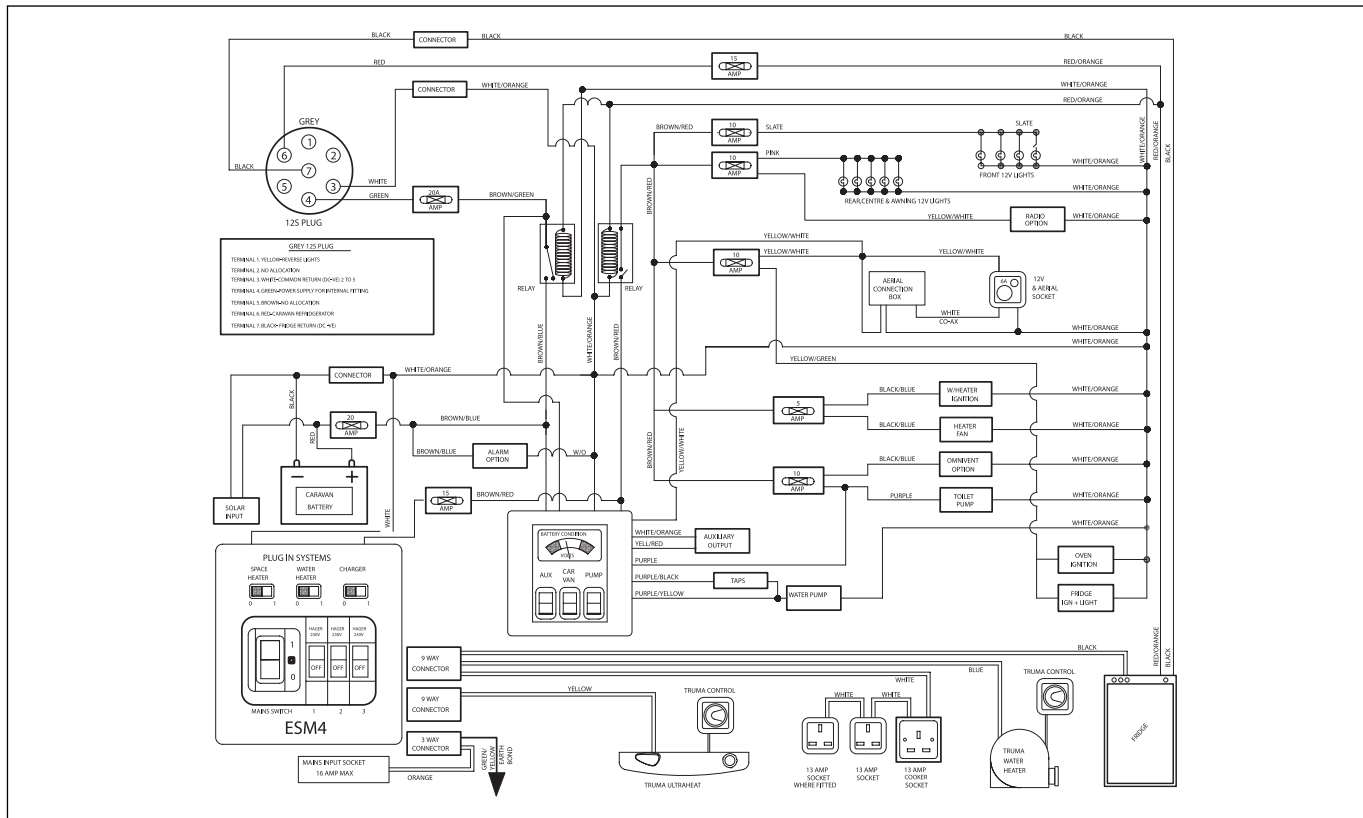

Wiring Diagrams

AWARD RANGE 2006 - 12V AND 230V

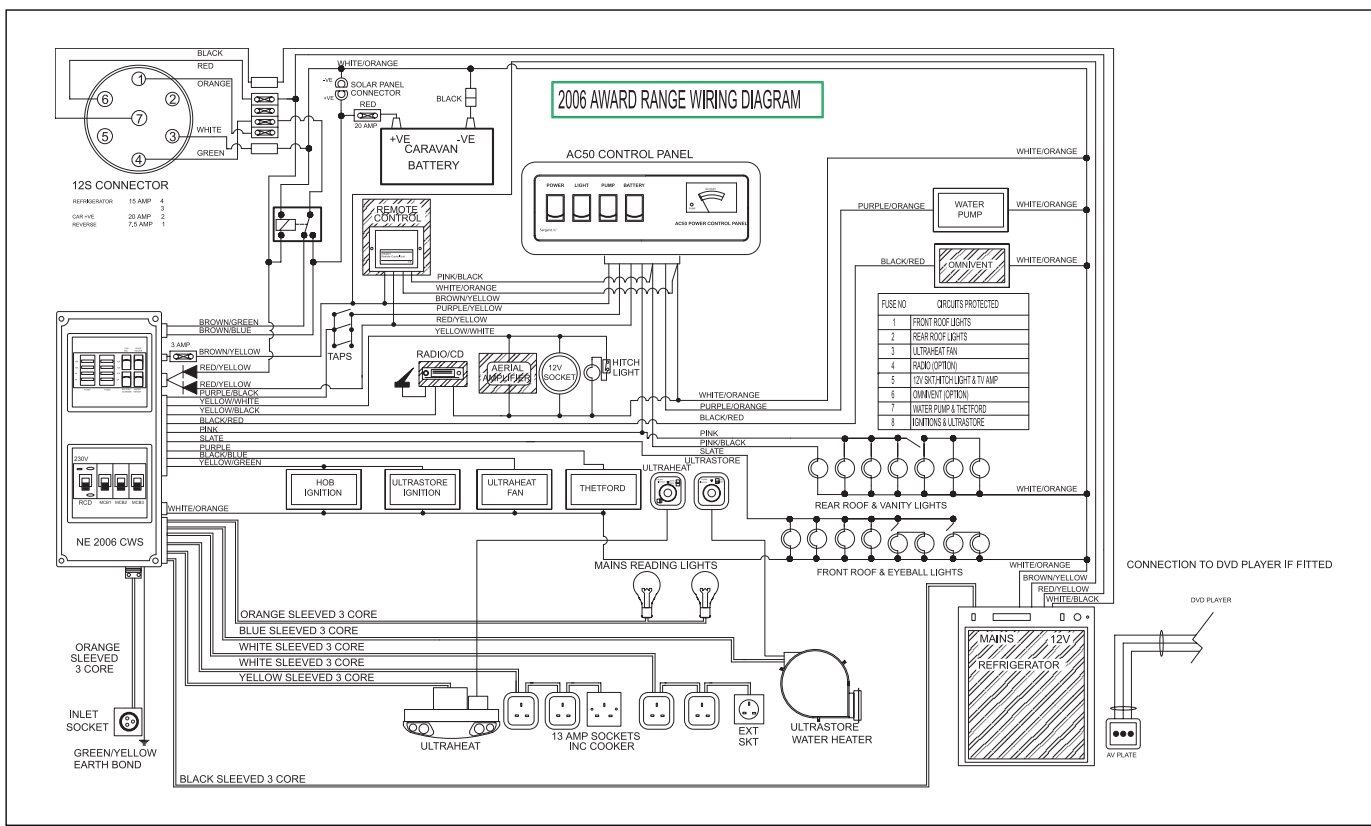

Wiring Diagrams

SUPREME RANGE 2006 - 12V AND 230V

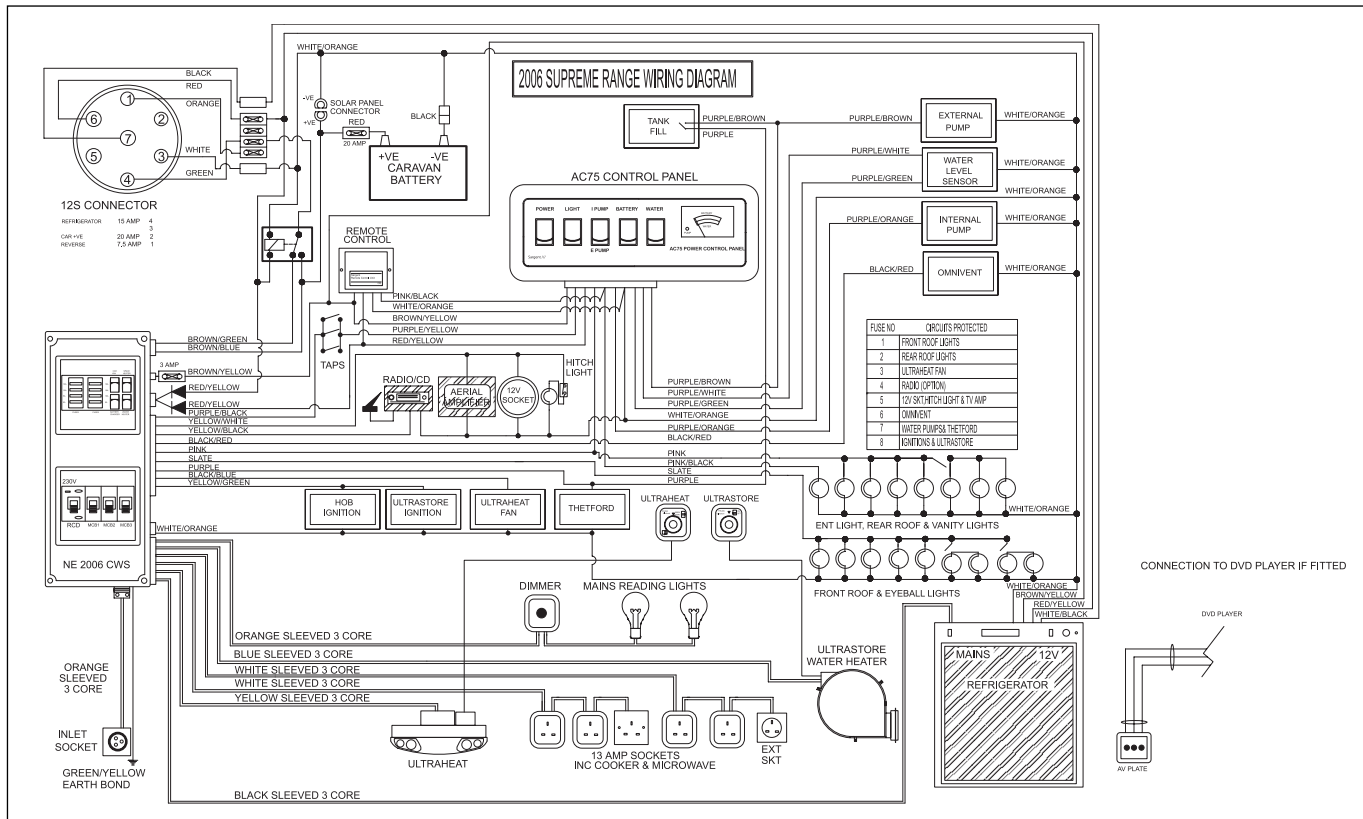

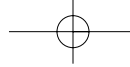

Bulb Replacement

	TYPE	RATING	JUBILEE	AWARD	SUPREME
ROAD LIGHTS					
Front marker lights	W5W	12v 5w	✓	✓	✓
Side marker	C5W	12v 5w	✓	✓	✓
Reversing light	P21	12v 21w	✓	✓	✓
Rear indicator light	PY21W Orange Bulb	12v 21w		✓	✓
Brake / tail light	P21/5W	12v 21w/5w	✓	✓	✓
Fog light	P21	12v 21w	✓	✓	✓
Number plate light	C5W	12v 5w	✓	✓	✓
High level brake light	T5/13.5	12v 2.3w		✓	✓
Hitch cover light	C5W	12v 5w		✓	✓
INTERIOR/OTHER					
Awning light	P21W	12v 20w	✓	✓	✓
Spot / reading lights	Halogen capsule	G4 12v 10w		✓	✓
Spot / reading lights	GU4MR11 Dichroic	GU4 12v 10w	✓		
Round ceiling lights	Fluorescent U-shape	12v 9w		✓	✓
Round ceiling lights	Halogen capsule	G4 12v 20w	✓		
Small white round ceiling light	Halogen capsule	G4 12v 10w	✓	✓	✓
Oval ceiling light	Halogen capsule	G4 12v 10w	✓		
Downlighters	Halogen capsule	G4 12v 10w		✓	✓
Twin bar mains lights	Small screw candle	230v 40w		✓	✓

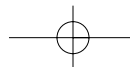

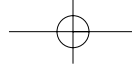

Ownership

NOTIFICATION OF CHANGE OF OWNERSHIP

If you sell your caravan, please notify the change of ownership by completing this page, detaching it and sending it to:
Swift Group Ltd., Dunswell Road, Cottingham, East Yorkshire, HU16 4JX.

DETAILS OF CARAVAN:	Model:	_____
	Chassis No:	_____
CURRENT OWNER:	Name:	_____
	Address:	_____

NEW OWNER:	Name:	_____
	Address:	_____

Please note that the benefit of any unexpired warranty cannot be transferred to the new owner until the change of ownership details above have been received.

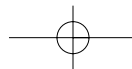
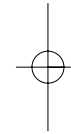
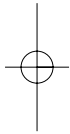

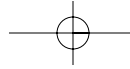

NCC Approved

All Swift Group models have been certified by the National Caravan Council for compliance with stringent European Standards, British Legislation and industry set Codes of Practice specifically relating to health and safety issues. The approval process covers the testing and inspection of critical areas of the product from fire safety, weights and dimensions, to gas, electrics and ventilation. Every Ace caravan carries the "NCC Approved Caravan" badge. The NCC also conduct unannounced inspections at the Swift factory to ensure continued compliance. NCC Approval gives you peace of mind that your caravan is legal and safe.

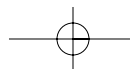
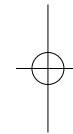
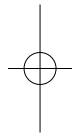

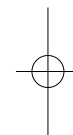
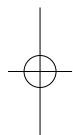
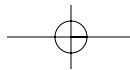

Enjoy the freedom

ACE CARAVANS, DUNSWELL ROAD, COTTINGHAM, EAST YORKSHIRE HU16 4JX.
TELEPHONE: 01482 875740 FAX: 01482 840082
e-mail: enquiry@swiftleisure.co.uk web site: www.ace-caravans.co.uk

A MEMBER OF THE SWIFT GROUP

Issued September 2005

1065317

